

 DYNON AVIONICS	19825 141 st PL NE Woodinville WA 98072 (425)402-0834		
	EFIS-D100		
Color:	Date 03/28/06	material:	Rev. A
Appendix A pg. 1 of 4			

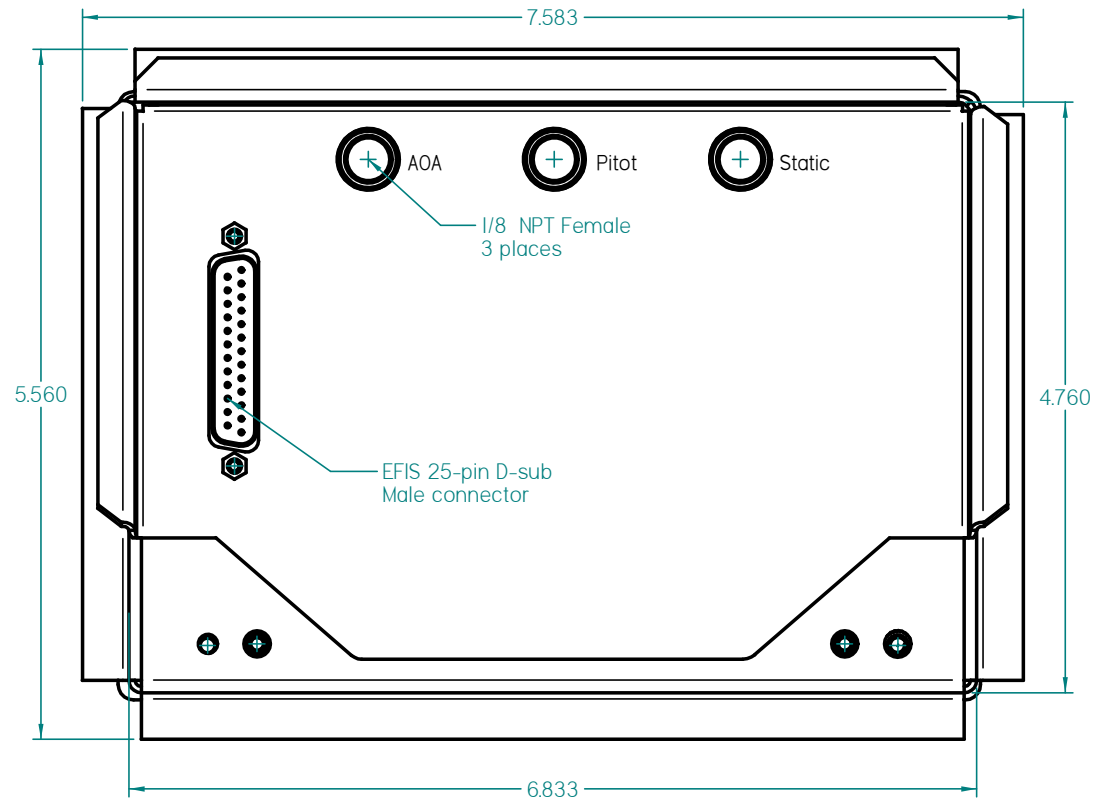

 DYNON AVIONICS	19825 141 st PL NE Woodinville WA 98072 (425)402-0834		
	<h2>EFIS-D100</h2>		
Color:	Date	material:	Rev.
Appendix A	03/28/06		A
pg. 2 of 4			

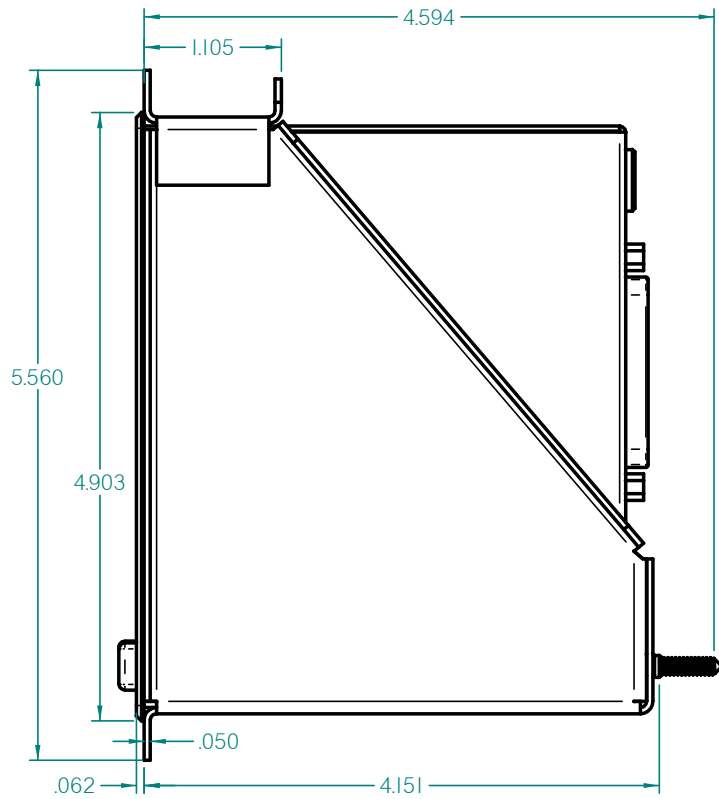

100425-000
Harness

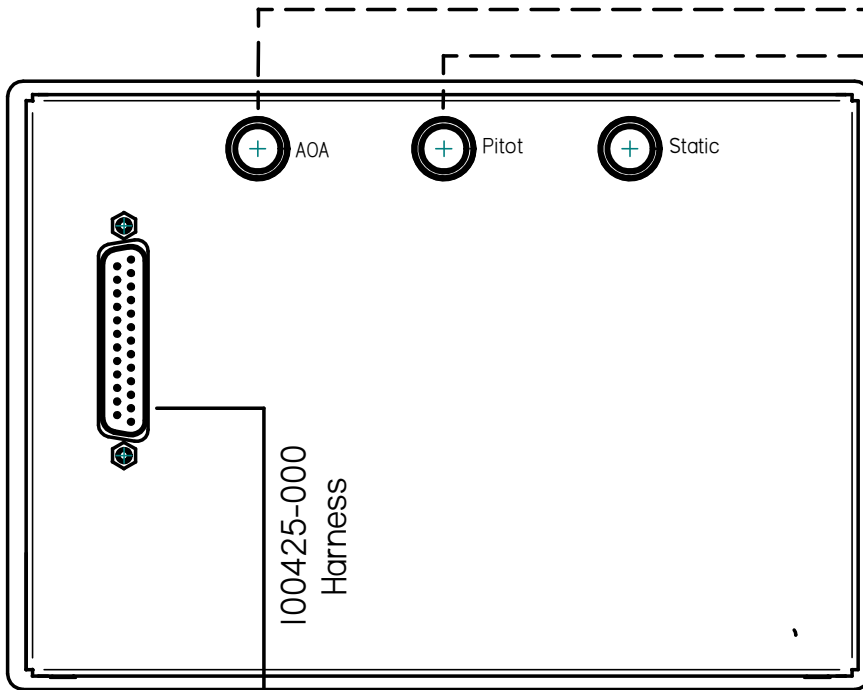
- Power
- Ground
- Clock Keep-Alive
- PC Serial interface
- Remote Compass
- Dynon Smart Avionics Bus
- Audio Output
- Altitude Encoder Output
- External Backup Power Input

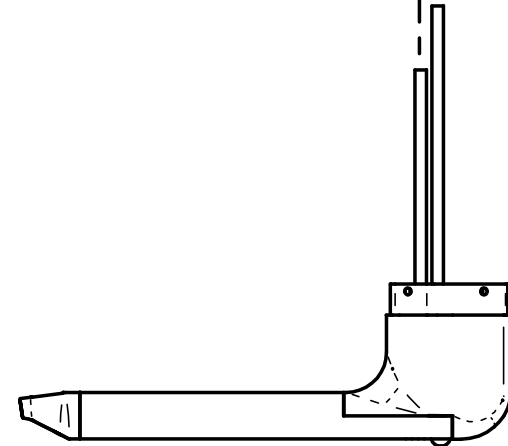

Angle of Attack
Pitot

 DYNON AVIONICS	19825 141 st PL NE Woodinville WA 98072 (425)402-0834		
	<h2>EFIS-D100</h2>		
Color:	Date	material:	Rev.
Appendix A	03/28/06		A
pg. 4 of 4			

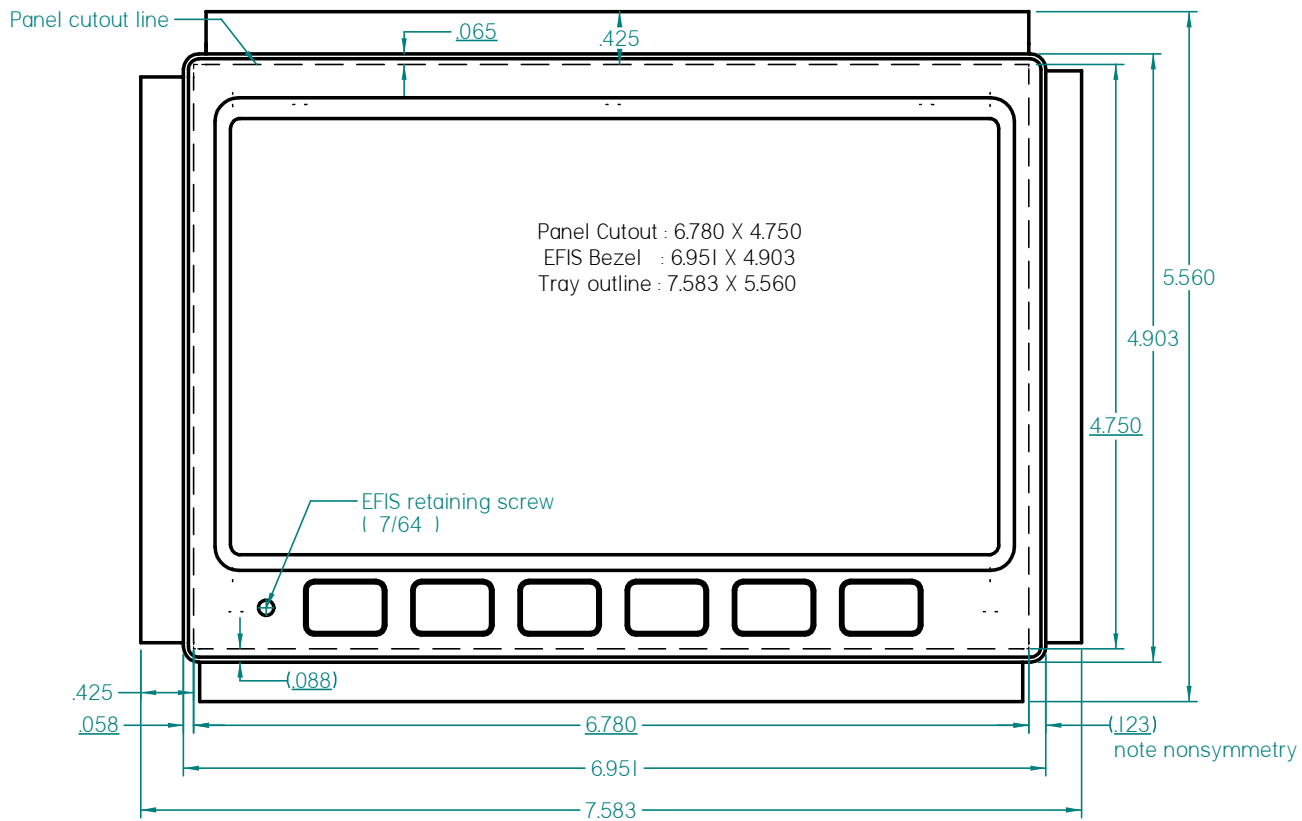

19825 141st PL NE
 Woodinville WA 98072
 (425)402-0834

EFIS-D100

Color:	Date 03/28/06	material:	Rev. A
Appendix A	pg. 3 of 4		