



SV-INTERCOM-2S

Installation and User Guide

This product is not approved for installation in type certificated aircraft.

102061-000

Revision D

2/20/2024

Copyright © 2024 by Dynon Avionics, Inc.

Dynon Avionics grants third parties' permission to print this document

Contact Information

Dynon Avionics, Inc.
19825 141st Place NE
Woodinville, WA 98072

Technical Support

Phone: +1 (425) 224-6736, 8:00 AM – 5:00 PM (Pacific Time) Monday – Friday
Email: support@dynon.com

Sales

Phone: +1 (425) 650-1269, 8:00 AM – 5:00 PM (Pacific Time) Monday – Friday
Email: sales@dynon.com

Find Us on the Web

dynon.com – Dynon homepage
dynon.com/docs – Product documentation
dynon.com/download – Software updates for products
dynon.com/support – Support resources
dynon.com/register – Register your Dynon Avionics product
shop.dynon.com – Dynon’s *secure* online store

Stay in Touch

dynon.com/newsletter – Sign up to receive Dynon’s newsletter
forum.flydynon.com – Dynon-hosted forum for customers and pilots
preflight.dynon.com – Dynon’s blog
facebook.com/dynonavionics
instagram.com/dynonavionics
twitter.com/dynon

Videos and Training

youtube.com/DynonAvionics – Training, events, and other videos on YouTube

Copyright

©2024 Dynon Avionics, Inc. All rights reserved. No part of this manual may be reproduced, copied, transmitted, disseminated, or stored in any storage medium, for any purpose without the express written permission of Dynon Avionics. Dynon Avionics hereby grants permission to download a single copy of this manual and of any revision to this manual onto a hard drive or other electronic storage medium to be viewed for personal use, provided that such electronic or printed copy of this manual or revision must contain the complete text of this copyright notice and provided further that any unauthorized commercial distribution of this manual or any revision hereto is strictly prohibited.

Information in this document is subject to change without notice. Dynon Avionics reserves the right to change or improve its products and to make changes in the content without obligation to notify any person or organization of such changes. Visit the Dynon Avionics website (dynon.com) for current updates and supplemental information concerning the use and operation of this and other Dynon Avionics products.

Limited Warranty

Dynon Avionics warrants this product to be free from defects in materials and workmanship for three years from date of shipment. Dynon Avionics will, at its sole option, repair or replace any components that fail in normal use. Such repairs or replacement will be made at no charge to the customer for parts or labor performed by Dynon Avionics. The customer is, however, responsible for any transportation cost and any costs that are incurred while removing, reinstalling, or troubleshooting the product. This warranty does not cover failures due to abuse, misuse, accident, improper installation or unauthorized alteration or repairs.

THE WARRANTIES AND REMEDIES CONTAINED HEREIN ARE EXCLUSIVE, AND IN LIEU OF ALL OTHER WARRANTIES EXPRESSED OR IMPLIED, INCLUDING ANY LIABILITY ARISING UNDER WARRANTY OF MERCHANTABILITY OR FITNESS FOR A PARTICULAR PURPOSE, STATUTORY OR OTHERWISE. THIS WARRANTY GIVES YOU SPECIFIC LEGAL RIGHTS, WHICH MAY VARY FROM STATE TO STATE AND IN COUNTRIES OTHER THAN THE USA.

IN NO EVENT SHALL DYNON AVIONICS BE LIABLE FOR ANY INCIDENTAL, SPECIAL, INDIRECT OR CONSEQUENTIAL DAMAGES, WHETHER RESULTING FROM THE USE, MISUSE OR INABILITY TO USE THIS PRODUCT OR FROM DEFECTS IN THE PRODUCT. SOME STATES AND COUNTRIES DO NOT ALLOW THE EXCLUSION OF INCIDENTAL OR CONSEQUENTIAL DAMAGES, SO THE ABOVE LIMITATIONS MAY NOT APPLY TO YOU.

Dynon Avionics retains the exclusive right to repair or replace the instrument or Software or offer a full refund of the purchase price at its sole discretion. SUCH REMEDY SHALL BE YOUR SOLE AND EXCLUSIVE REMEDY FOR ANY BREACH OF WARRANTY.

These instruments are not intended for use in type certificated aircraft at this time. Dynon Avionics makes no claim as to the suitability of its products in connection with FAR 91.205.

Dynon Avionics' products incorporate a variety of precise, sensitive electronics. SkyView products do not contain any field/user-serviceable parts. Units found to have been taken apart may not be eligible for repair under warranty. Additionally, once a Dynon Avionics unit is opened up, it is not considered airworthy and must be serviced at the factory.

Dynon Avionics Returns and Warranty web page can be found at dynon.com/warranty.

Revision History

REV	DATE	APPROVED	DESCRIPTION OF CHANGE
D	February, 2024	ECO # 390087	<ul style="list-style-type: none">Added SV-HARNES-INT to Section 3.2.
C	September, 2022	ECO # 380285	<ul style="list-style-type: none">Revised document for inclusion of SV-COM-760 COM radio and repackaging of the SV-COM-X25/X83 and SV-COM-C25 COM radio kits.
B	July, 2021	ECO # 348817	<ul style="list-style-type: none">Reformatted document using new template.Added information for SV-COM-T25 and SV-COM-T8 radios.Revised Dual Radio PTT Installation section.
A	June, 2013	ECO # 126683	Initial Release

Table of Contents

1	Introduction	6
1.1	Dynon Avionics Product Registration	6
1.2	Warranty Information	6
1.3	Printing This Document	6
1.4	Document Iconography	7
1.5	Related Documents	7
2	System Overview.....	8
3	Installing the SV-INTERCOM-2S.....	9
3.1	Mechanical Installation	9
3.2	Electrical Installation.....	11
4	Using the SV-INTERCOM-2S	22
4.1	Power	22
4.2	LED Power/Transmit Indicator.....	22
4.3	Volume	22
4.4	Squelch Adjustment.....	22
4.5	Front Music In Jack	23
4.6	Muting Inputs	23
4.7	Selectable Auto Mute (music only)	23
4.8	Fail-safe Operation	23
4.9	Radio Push-to-Talk (PTT) Behavior and Priority	23
4.10	Dual Radio Operation	23

1 Introduction

Thank you for purchasing the Dynon Avionics Intercom system! This section provides some important product information and general usage instructions for this document.

1.1 Dynon Avionics Product Registration

Please take a moment to register your Dynon Avionics Intercom system at dynon.com/register. Registering your product with Dynon Avionics ensures that your contact information is up-to-date. This helps verify product ownership, can expedite warranty claims, and allows us to notify you in the event a service bulletin is published for your product. You can also optionally sign up to receive other Dynon Avionics news and product announcements. Dynon Avionics will not share your contact information with third parties.

1.2 Warranty Information

Dynon Avionics' products incorporate a variety of precise, sensitive electronics. SkyView products do not contain any field / user-serviceable parts. Units found to have been taken apart may not be eligible for repair under warranty. Additionally, once a Dynon Avionics unit is opened, it is not considered airworthy and must be serviced at the factory.

1.3 Printing This Document

To reduce waste and confusion resulting from outdated information in print, Dynon Avionics no longer provides this guide in printed form. The latest, most up-to-date, and most complete version of this guide – and all Dynon Avionics documentation – is always available at dynon.com/docs. Rather than printing this guide on a home printer (typically, with relatively expensive inkjet printing) we recommend that you take the PDF file of this guide to be printed at a large office supply retailer that provides printing services. The statement on the cover of this guide: **Permission to print this document is granted to third parties.**, is sufficient permission to do so.

It is also handy to have the electronic version on your tablet computer as reference as you can perform keyword searches, and the electronic version includes figures and diagrams that contain important color information. For example, we have found that the free “iBooks” application that can be installed on Apple iPad tablet computers can import this guide’s PDF file for easy reference. Similar PDF reader applications are available for Android devices.

In the electronic (.PDF) version of this guide, page and section references in the Table of Contents and elsewhere act as hyperlinks taking you to the relevant location in the guide. The latest electronic version (.PDF) of this guide may be downloaded from our website at: dynon.com/docs.

1.4 Document Iconography

The following icons are used in this guide:



This icon denotes information that merits special attention.



This icon denotes a helpful tip.

1.5 Related Documents

- *SkyView System Installation Guide*

2 System Overview

The SV-INTERCOM-2S is a two-place stereo intercom for experimental and light aircraft. Although it is designed to seamlessly complement a SkyView system, its flexible design allows it to be used in any experimental or light sport aircraft panel that does not required a TSO'd intercom.

The SV-INTERCOM-2S features:

- **Ample Inputs** — provide connection to EFIS systems, stereo music, and other technology in your panel.
- **High-Fidelity Audio Circuitry** — no more scratchy, garbled voices. Stereo music output that sounds fantastic!
- **Dual Radio Capability** — dual radio outputs allow two third-party radios, or a third-party radio and a Dynon SV-COM-760 or SV-COM-T25/T8 radio, to operate alongside one another.
- **Fail-Safe** — immediate pilot headset switch-over to primary radio, allowing communication without intercom power.
- **Horizontal and Vertical Faceplates** — both configurations, plus headset jack, included in kit.
- **Selectable Auto Mute** — turns down the music volume when a radio or other non-muting input (like an EFIS alert) receives audio. A single knob press toggles whether intercom speech also mutes the music.
- **Independent Intercom Voice Activation** — reduces background noise, talking on one headset will not open squelch on the other. Radio broadcasts are also isolated so that only the person pressing the PTT is heard over the air.



Figure 1: Vertical Faceplate / Mounting



Figure 2: Horizontal Faceplate / Mounting

3 Installing the SV-INTERCOM-2S

This section provides information for the mechanical and electrical installation of the SV-INTERCOM-2S.

3.1 Mechanical Installation

The SV-COM-PANEL mounts directly to the instrument panel in either a vertical or horizontal configuration (see [Figure 1](#) and [Figure 2](#) for reference). Use [Figure 4](#) for space planning and use [Figure 3](#) as a guide to prepare, drill, and cut the instrument panel for the SV-INTERCOM-2S module. Fasten the module to the instrument panel using the included screws to anchor nuts installed behind the panel (see [Figure 3](#) for specification). If access behind the panel allows it, using standard #6-32 lock nuts is acceptable.



Do not use [Figure 3](#) as a template to cut instrument panel.

Do not rivet the SV-INTERCOM-2S directly to the aircraft as this will hinder future removal if necessary.



The SV-INTERCOM-2S kit includes #6-32 hex-drive round head fasteners. Fasteners are 5/8" in length and require a 5/64" hex drive tool.

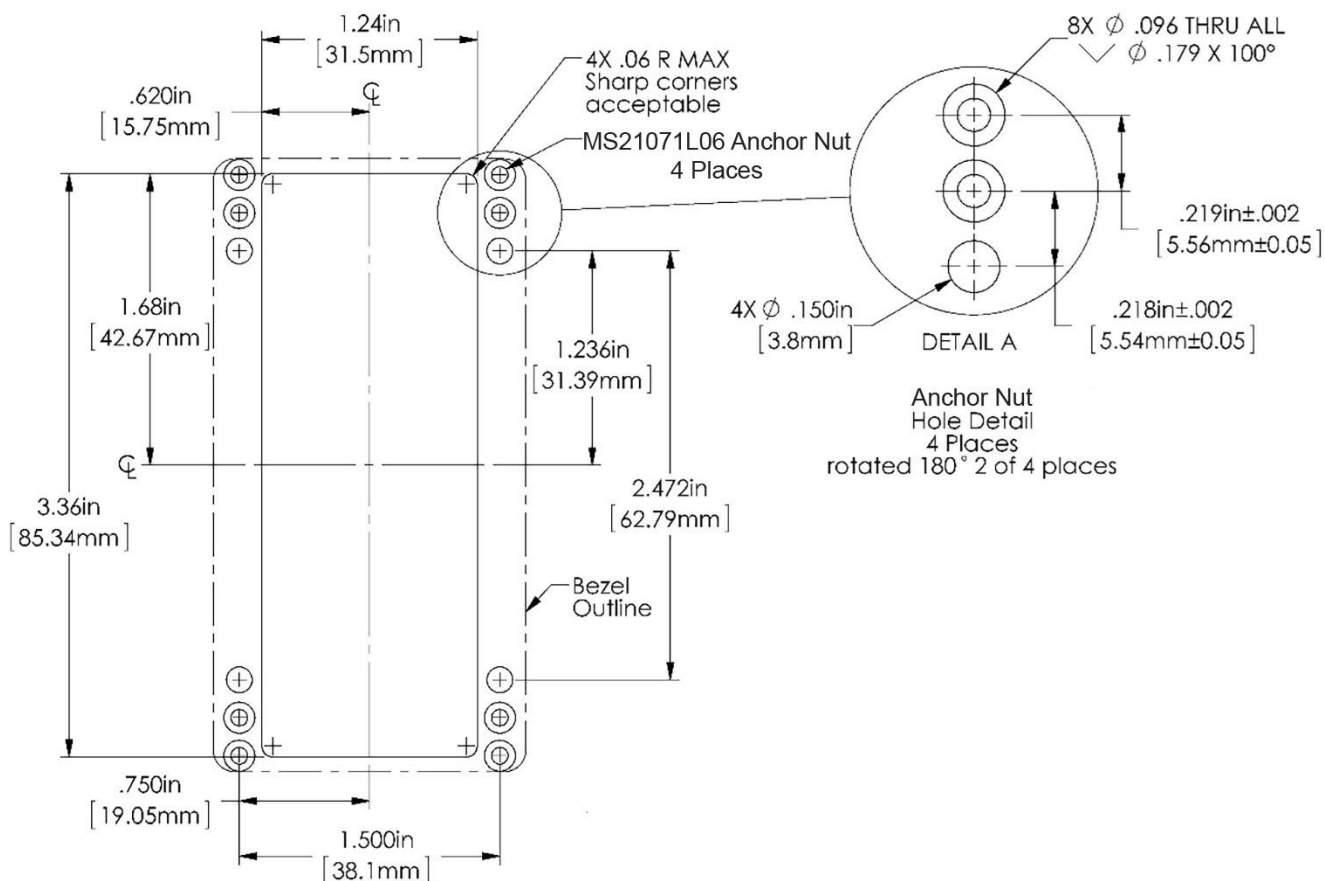

Figure 3: Panel Cut-Out Dimensions (Not to Scale)

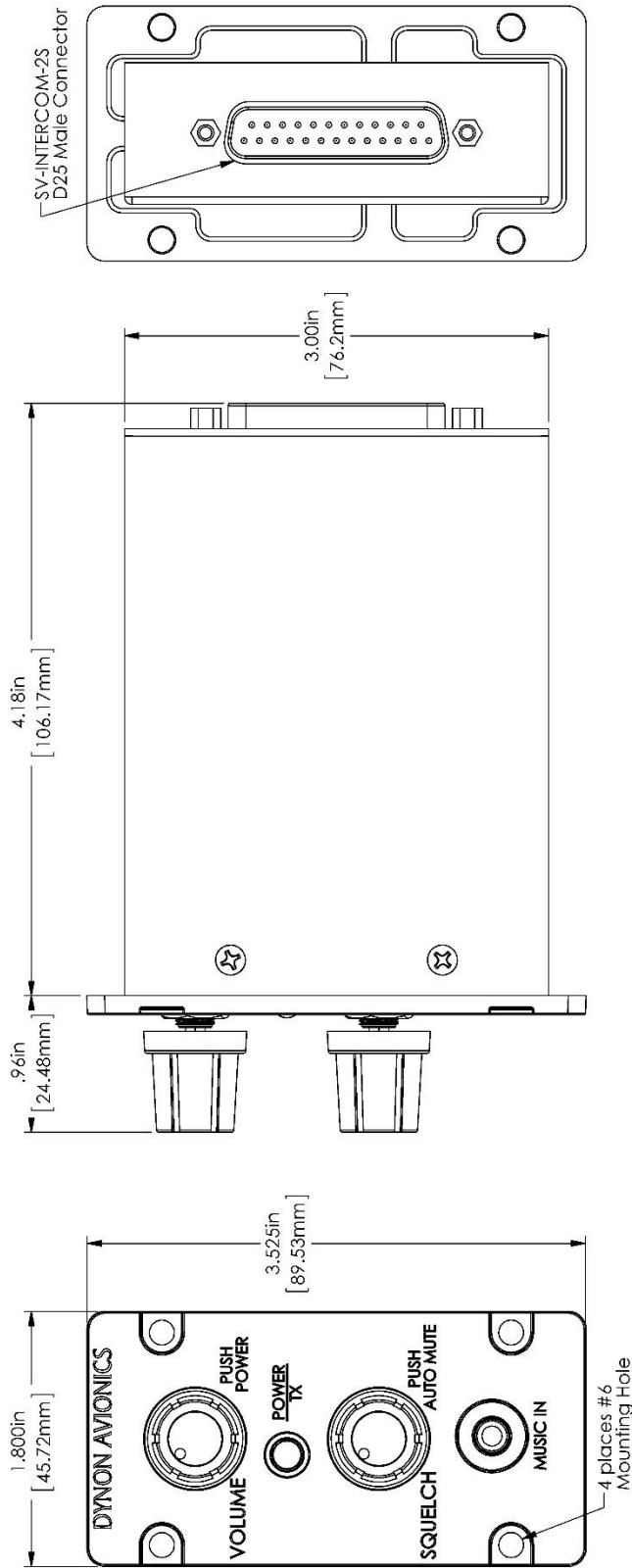

Figure 4: Space Requirements (Not to Scale)

3.2 Electrical Installation

The SV-INTERCOM-2S has one D25M connector for connection to SkyView and other devices. Installers can either purchase and use the Dynon D25F wire harness (SV-HARNESS-INT) or fabricate their own D25F wire harness using the guidance below.

3.2.1 Dynon Wire Harness

Follow the guidance in [Table 1](#) to connect the SV-INTERCOM-2S to SkyView and other devices.

Table 1: SV-HARNESS-INT Connections

SV-HARNESS-INT LABEL	COLOR	FUNCTION	INTERCOM PIN #	CONNECTION
10-30 VDC	Red	Power	13	Ship Power (+)
GND	Black	Ground	1	Ship Ground (-)
RADIO AUDIO INPUT	White	Radio Audio Input (High)	14	SV-COM-760/T25/T8 Pin 2 SV-COM-425 Pin 10
	White/Blue	Radio Audio Input (Low)	GND	SV-COM-760/T25/T8 Pin 1 SV-COM-425 Pin 9
	Shielded	No Connection	GND	No Connection
RADIO MIC OUT	Red	Radio Mic Output	25	SV-COM-760/T25/T8 Pin 23 SV-COM-425 Pin 1
	Blue	Mic Ground	GND	SV-COM-760/T25/T8 Pin 9 SV-COM-425 Pin 2
	Yellow	Radio Mic PTT Output	12	SV-COM-760/T25/T8 Pin 15 SV-COM-425 Pin 5
	Shielded	No Connection	GND	No Connection
PILOT PHONES	Red	Pilot Right	22	Pilot Phone Jack
	Yellow	Pilot Left	9	
	Blue	Pilot Ground	GND	
	Shielded	no connection	GND	No Connection
COPILOT PHONES	Red	Copilot Right	21	Copilot Phone Jack
	Yellow	Copilot Left	8	
	Blue	Copilot Ground	GND	
	Shielded	No Connection	GND	No Connection
PILOT MIC	Red	Pilot ptt	10	Pilot Mic Jack
	Yellow	Pilot Mic	23	
	Blue	Pilot Ground	2	
	Shielded	No Connection	GND	No Connection
COPILOT MIC	Red	Copilot PTT	16	Copilot Mic Jack
	Yellow	Copilot Mic	3	
	Blue	Copilot Ground	2	
	Shielded	No Connection	GND	No Connection
EFIS AUDIO L	Brown	EFIS Audio Left	19	SkyView D37 Pin 13



SV-HARNESS-INT LABEL	COLOR	FUNCTION	INTERCOM PIN #	CONNECTION
EFIS AUDIO R	Gray	EFIS Audio Right	6	SkyView D37 Pin 31
EFIS AUDIO GND	Black	EFIS Audio Ground	20	SkyView D37 Pin 30
EFIS DIM	White	EFIS Dimming Input	5	SkyView D37 Pin 26
MUSIC IN	Red	Music in Left	24	Music Input Jack
	Yellow	Music in Right	11	
	Blue	Music in Ground (Low)	18	
	Shielded	No Connection	GND	No Connection
NON-MUTING INPUT	White	High	17	User Defined
	White/Blue	Low	20	User Defined
	Shielded	No Connection	GND	No Connection
MUTING INPUT	White	Input (High)	4	User Defined
	White/Blue	Ground (Low)	20	User Defined
	Shielded	No Connection	GND	No Connection

3.2.2 Fabricated Wire Harness

When fabricating a D25F wire harness, 20 AWG wire is recommended for power and ground wires, and 22 AWG wire is recommended for all other connections. Shielded wire is required for audio connections (see Section 3.2.3 for more information).

See Table 2 for harness pin/wire connections; see Figure 5 through Figure 7 for application-specific wiring diagrams.

Table 2: Pin/Wire Connections

INTERCOM PIN #	SKYVIEW PIN #	FUNCTION	ADDITIONAL INFORMATION
1	N/A	Ground	The shields of all shielded audio cables should be connected to this pin.
2	N/A	Microphone Ground	Pilot and Copilot
3	N/A	Copilot Microphone	
4	N/A	Auxiliary Muting Input	This mono audio signal mutes when audio signals are received on other non-muting inputs and radio inputs. Use this input for non-critical mono audio signals.
5	Display Unit: D37, Pin 26	LED Dimming Control	Used for SkyView Dimming Output. <i>NOTE: If more than one SkyView display, connect this to only one of the SkyView displays.</i>

INTERCOM PIN #	SKYVIEW PIN #	FUNCTION	ADDITIONAL INFORMATION
6	Display Unit: D37, Pin 31	SkyView Audio, Right	This is the right channel of the stereo non-muting input, typically used to receive audio from SkyView or other EFIS systems with stereo output.
7	SV-COM-760, -T25/T8 #2: D15, Pin 2 SV-COM-425 #2: D15, Pin 10	Radio 2 Audio Input	Connects to COM radio #2 Headphones Output. This audio signal does not mute. Typically used for a second COM, a NAV radio, or other mono avionics alerts.
8	N/A	Copilot Headphones, Left	
9	N/A	Pilot Headphones, Left	
10	N/A	Pilot Microphone PTT	
11	N/A	Music In, Right	The Music In left and right channels (Pins 11 and 24) are over-riden by the inputs connected to the stereo Music In jack on the front of the Intercom.
12	SV-COM-760, -T25/T8 #1: D15, Pin 15 SV-COM-760, -T25/T8 #2: D15, Pin 15 SV-COM-425 #1: D15, Pin 5 SV-COM-425#2: D15, Pin 5	Radio PTT	For dual COM radio installations, connect this pin to the output of an externally mounted COM control switch. Connect the switch inputs to the COM 1 and COM 2 PTT outputs.
13	N/A	Power In	
14	SV-COM-760, -T25/T8 #1: D15, Pin 2 SV-COM-425 #1: D15, Pin 10	Radio 1 Audio Input	Connects to COM radio #1 audio output.
15	SV-COM-760, -T25/T8 #2: D15, Pin 23 SV-COM-425 #2: D15, Pin 1	Radio 2 Microphone Output	Connects to aircraft radio #2 MIC input.
16	N/A	Copilot Mic PTT	
17	N/A	Aux Non-Muting Input	This mono audio signal does not mute when audio signals are received on other inputs. Use this input for critical audio signals such as a NAV radio or avionics alerts.
18	N/A	Music Lo	Used exclusively for stereo audio ground. Should not be used for other ground connections.



INTERCOM PIN #	SKYVIEW PIN #	FUNCTION	ADDITIONAL INFORMATION
19	Display Unit: D37, Pin 13	SkyView Audio, Left	This is left channel of the stereo non-muting input, typically used to receive audio from SkyView or other EFIS system with stereo output.
20	Display Unit: D37, Pin 30	SkyView Ground	Used exclusively for non-muting stereo input grounds, such as EFIS stereo audio output grounds. Do not connect to any other grounds.
21	N/A	Copilot Headphones Right	
22	N/A	Pilot Headphones Right	
23	N/A	Pilot Microphone	
24	N/A	Music In, Left	The Music In left and right channels (Pins 24 and 11) are over-ridden by the inputs connected to the stereo Music In jack on the front of the Intercom.
25	SV-COM-760, -T25/T8 #1: D15, Pin 23 SV-COM-425 #1: D15, Pin 1	Radio 1 Microphone Output	

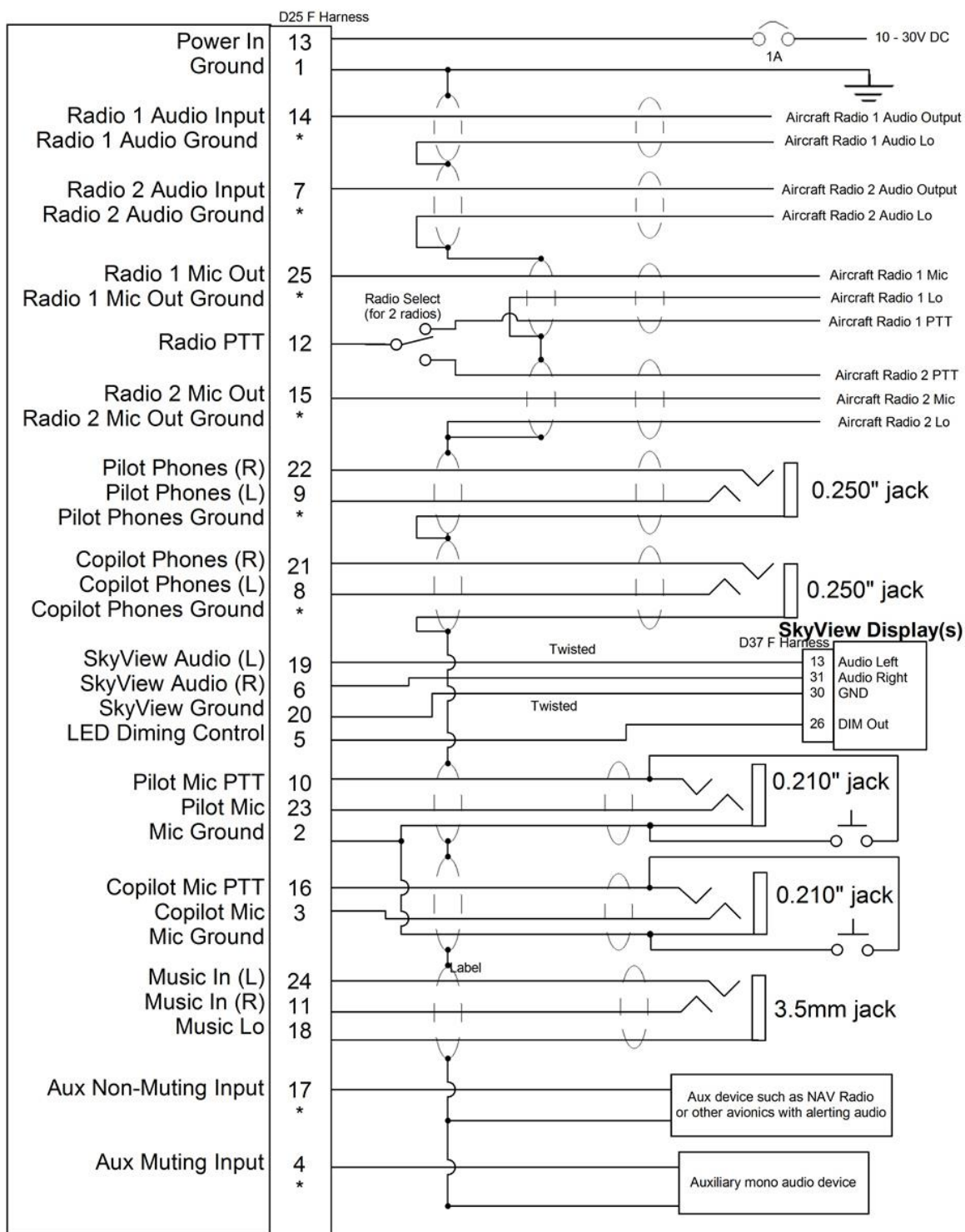

Figure 5: Generic COM Radio Wiring Diagram

* == While the audio grounds labeled with a * ultimately come back to the main ground on pin 1, they should NOT be wired directly from the source audio device to any ground (pin 1 or otherwise) directly. Instead, to minimize noise and interference, their ground lines should be routed with their audio signal inside the required shielded cable as far as possible and connected to ground as close to the intercom as possible. Connecting these grounds to the shield (which is also grounded at pin 1) at the intercom end of the harness is a suitable way to accomplish this goal.

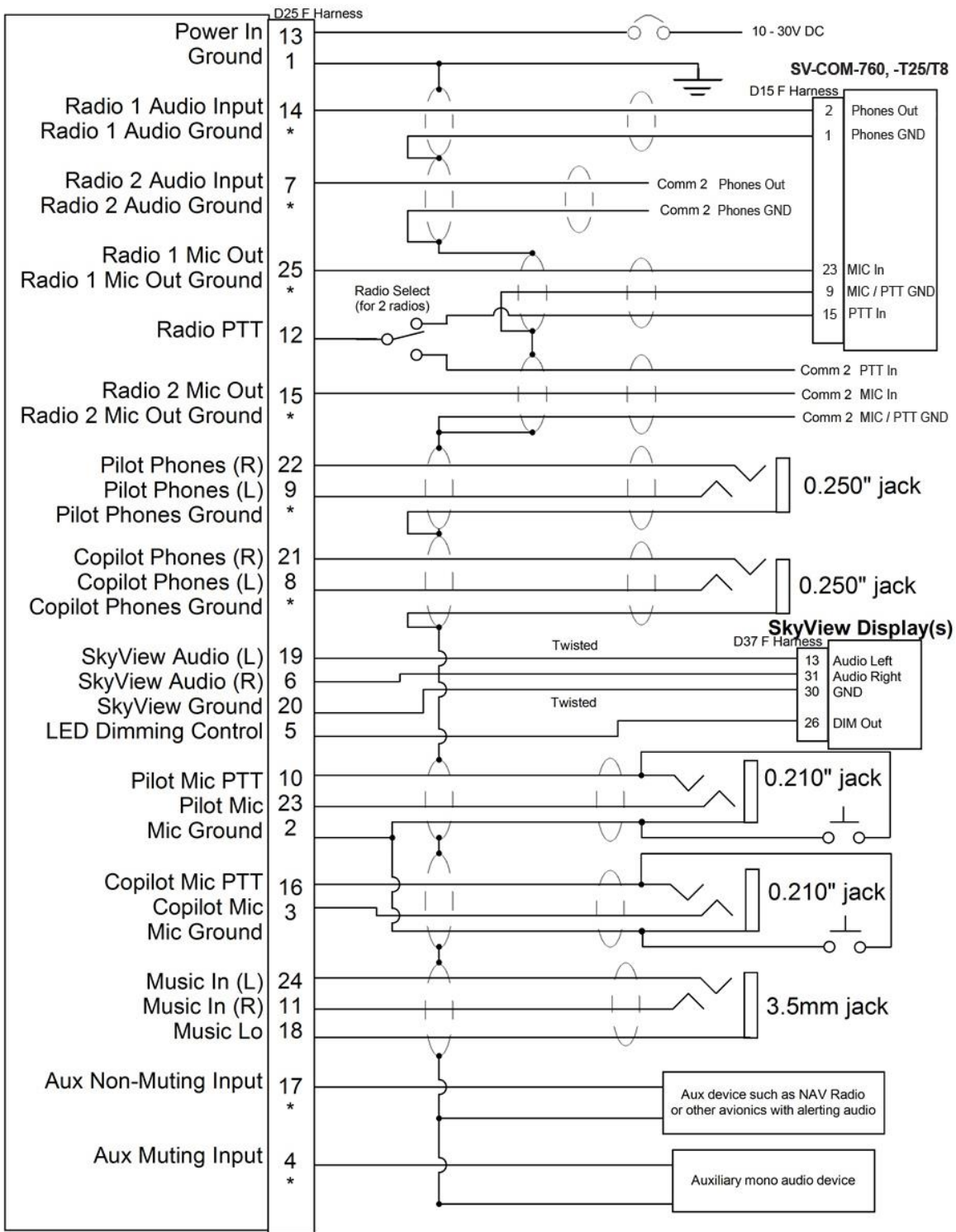

Figure 6: SV-COM-760, -T25/T8 Wiring Diagram

* == While the audio grounds labeled with a * ultimately come back to the main ground on pin 1, they should NOT be wired directly from the source audio device to any ground (pin 1 or otherwise) directly. Instead, to minimize noise and interference, their ground lines should be routed with their audio signal inside the required shielded cable as far as possible and connected to ground as close to the intercom as possible. Connecting these grounds to the shield (which is also grounded at pin 1) at the intercom end of the harness is a suitable way to accomplish this goal.

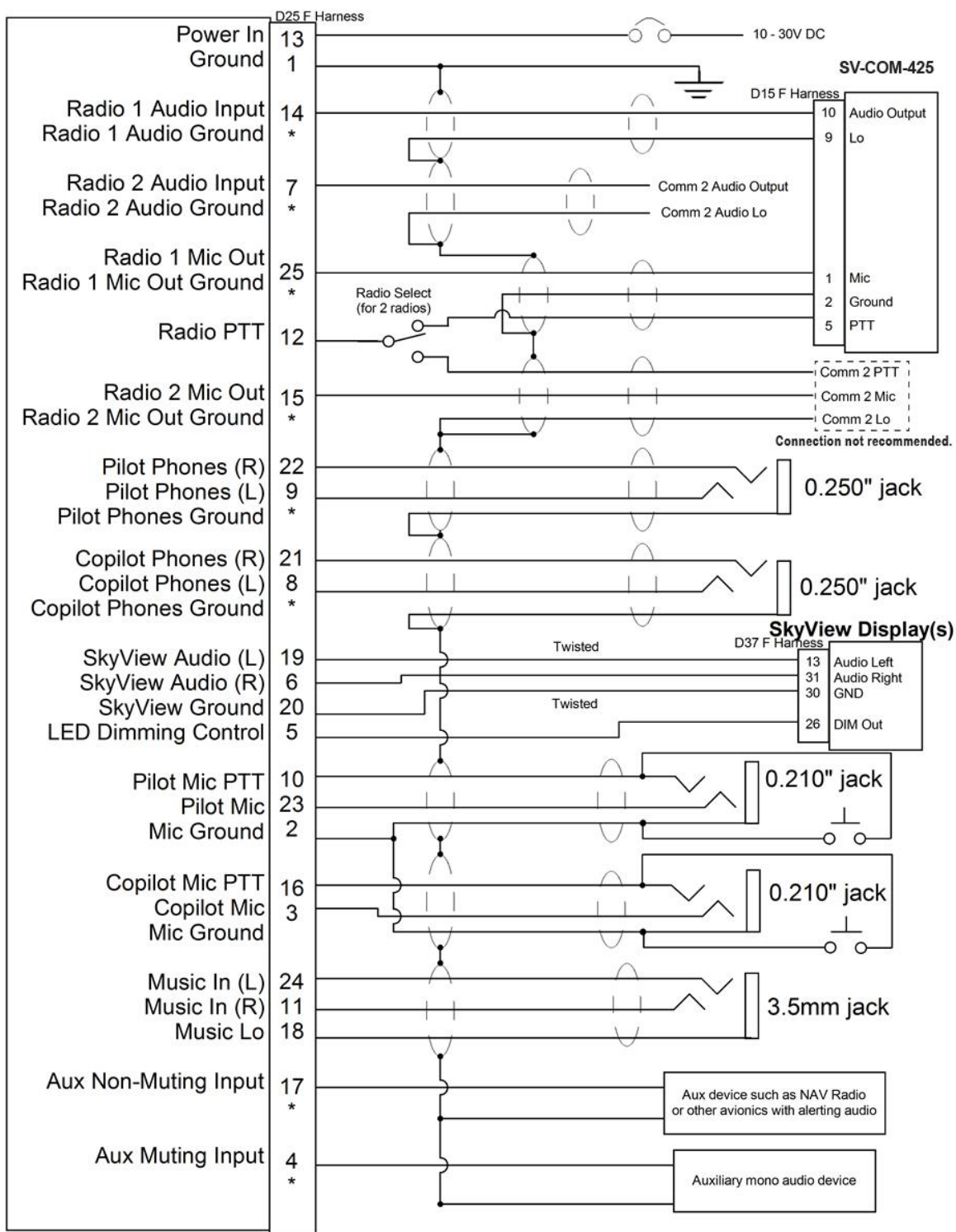

Figure 7: SV-COM-425 Wiring Diagram

* == While the audio grounds labeled with a * ultimately come back to the main ground on pin 1, they should NOT be wired directly from the source audio device to any ground (pin 1 or otherwise) directly. Instead, to minimize noise and interference, their ground lines should be routed with their audio signal inside the required shielded cable as far as possible and connected to ground as close to the intercom as possible. Connecting these grounds to the shield (which is also grounded at pin 1) at the intercom end of the harness is a suitable way to accomplish this goal.

3.2.3 Additional Electrical Installation Guidance

The following is a list of guidelines for electrically installing the SV-INTERCOM-2S:

- **DIM INPUT (Pin 5) with Multiple SkyView Displays:**

Only one SkyView display unit's DIM OUTPUT (Pin 26) should be connected to the SV-INTERCOM-2S's DIM INPUT (Pin 5). Do not connect Pin 26 signals from multiple SkyView display units together.

- **DIM INPUT (Pin 5) without SkyView Displays:**

To vary the backlighting brightness of the SV-INTERCOM-2S without a SkyView system, use a PWM dimmer that switches the ground side of the lighting circuit. A varying voltage or resistance will not work.

Hook the SV-INTERCOM-2S's DIM INPUT (Pin 5) to the negative terminal of the dimmer and the transmit/power LED will vary brightness with dim control. This input may be connected in parallel with other loads that are controlled by the dimmer.

- **Audio Output from Multiple SkyView Displays:**

The audio outputs from all SkyView display units must be connected before connection to their respective pins on the SV-INTERCOM-2S.

- **Allow Sufficient Space Behind the SV-INTERCOM-2S for Connector and Cables:**

Audio wiring typically uses shielded cables, which can be stiffer and larger than DC or data communications wiring typically used for avionics. It is recommended to leave ample room beyond the connector for stiff, shielded wires to exit the connector and to form a large-enough "service loop" to allow the SV-INTERCOM-2S to be removed from the panel with the connector for service and/or updates to the audio wiring if needed.

- **Shielded Audio Cabling is Required:**

In an audio system like the SV-INTERCOM-2S, it is required to use *separate* shielded cables for microphone and other input signals, and headphone and other output signals. If separate shielded cables are not used, squealing, hum, and other undesirable audio will likely be heard. To reduce electrical noise from being induced into audio circuits, separate the audio wiring as much as possible from other electrical wiring.

- **Audio Cable Shields need a Common Termination:**

A ground loop is more than one electrical path to ground. Ground loops are a common source of noise with audio systems. Because other electrical loads can cause large current flows in a ground path, audio system grounds should be isolated as much as possible from electrical ground. Except where specifically directed in the wiring diagrams above, the shields for all audio cables should terminate at a single point, with that point connected directly to the SV-INTERCOM-2S's MASTER GROUND (Pin 1). Additionally, the point should be as close to the SV-INTERCOM-2S side of your harness as possible.

- **Headset jacks need to be electrically isolated from the airframe:**



If the instrument panel is electrically conductive (i.e., aluminum), the headset jacks must be electrically isolated from the panel. Insulating washers are included with the headset jacks. Another method is to mount the jacks on a small plastic plate instead of mounting the jacks directly to the panel.



If using nylon washers, discard the steel washer included with the kit.

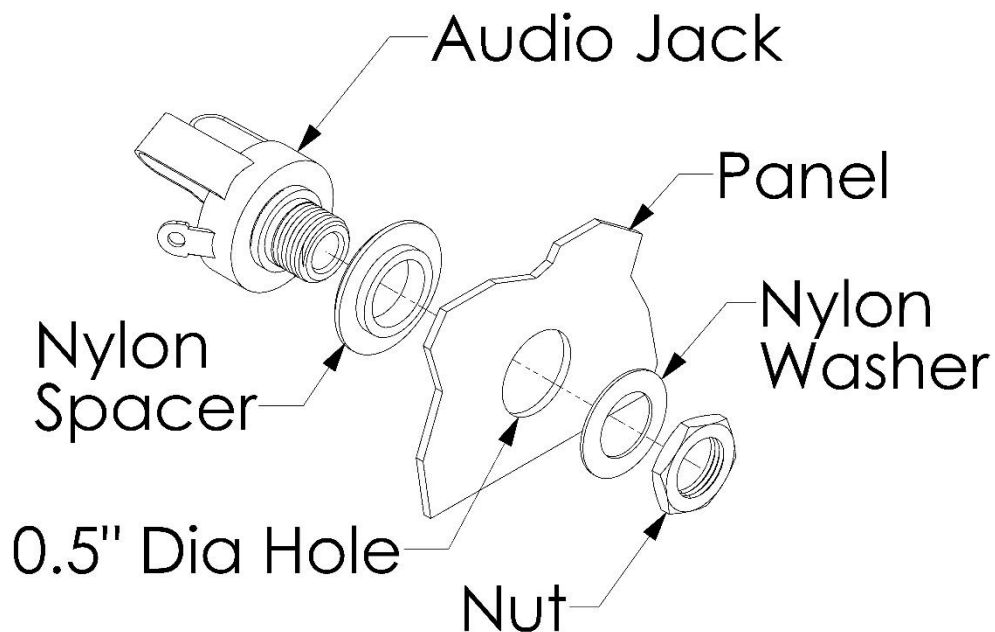

Figure 8: Audio Jack Installation

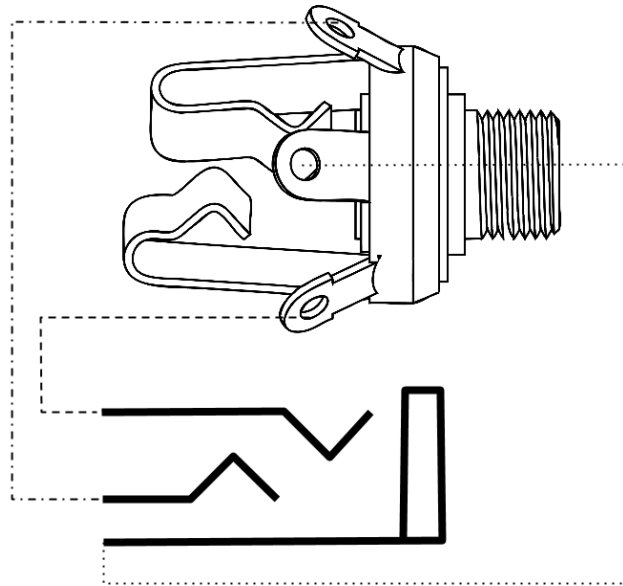

Figure 9: Headset Jack Schematic Symbol Guide

3.2.4 Dual Radio PTT Installation

The SV-INTERCOM-2S has two separate radio outputs that can be connected to individual COM radios. In a dual COM radio installation, the PPT output signal (Radio PTT (Pin 12)) requires an external switch to control which radio receives the PTT output signal, and thus transmits. Installers will need to source an external single pole, double throw (SPTD) switch for this installation.



For optimal dual COM radio performance, Dynon suggests using a full-featured audio panel for COM radio source control.



Dual radio operation requires COM radios with transmit (TX) interlock functionality. The SV-COM-425 does not have TX interlock functionality; and therefore, is not suitable for dual COM radio installations.



For best dual COM radio performance without a full-featured audio panel, Dynon suggests pairing an SV-COM-760 or SV-COM-T25/T8 with a third-party radio that has TX interlock functionality. (See [Figure 10](#) for installation guidance.)

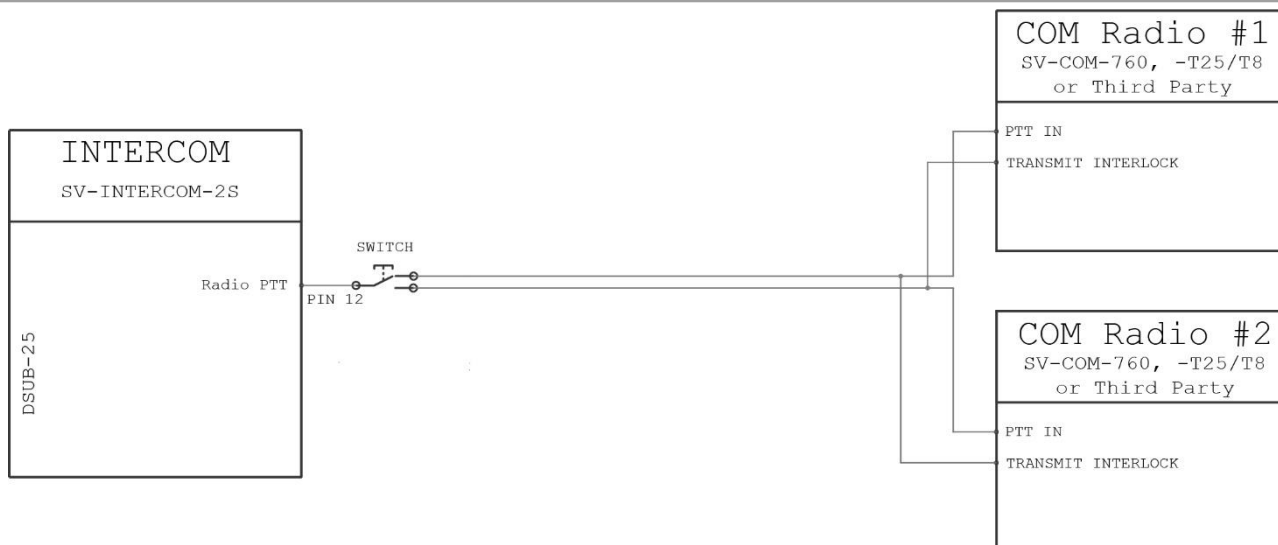

Figure 10: Dual COM Radio PTT Electrical Connections

4 Using the SV-INTERCOM-2S

This section provides guidance for using the SV-INTERCOM-2S.

4.1 Power

To manually power the SV-INTERCOM-2S on/off, press the volume knob.

The power switch remembers the on/off state. Once the SV-INTERCOM-2S is powered on, aircraft power can be used to turn the Intercom on and off in normal use. Therefore, the power switch need not be routinely used.

4.2 LED Power/Transmit Indicator

The LED indicator light in the center of the SV-INTERCOM-2S faceplate is green when the the unit is powered on. When either the pilot or co-pilot PTT switch is depressed, the LED becomes orange to indicate radio transmission.

The LED can be dimmed by a capable device such as a SkyView system. There is no manual dimming control on the SV-INTERCOM-2S itself.

4.3 Volume

The volume knob adjusts the audio levels of the stereo music input and pilot-to-copilot intercom communication only. It does not adjust the volume level of aircraft radios or other devices that are connected. Adjust the volume levels on your radios and other audio devices to achieve the desired volume balance between all audio devices in the aircraft.

4.4 Squelch Adjustment

The SV-INTERCOM-2S has voice-activated (VOX) microphone channels to reduce background noise from the aircraft when no one is speaking. When either the pilot or co-pilot speaks into their headset, their microphone channel is activated, allowing them to be heard by the other person. The microphone audio level that is required to activate a microphone channel is adjusted with the squelch knob.

To adjust squelch with the engine running:

1. While no one is talking, turn the squelch knob until you hear background noise in your headset.
2. Adjust the squelch until you no longer hear background noise.
3. With the microphone close to your mouth, talk to confirm that normal speech levels activate the microphone. The VOX feature will automatically close the microphone after you finish speaking.

To reduce background noise, the pilot and co-pilot microphones are activated individually.

4.5 Front Music In Jack

The SV-INTERCOM-2S has wiring provisions for a permanent stereo music source via its rear-mounted wiring connector.

A music device can also be plugged in to the standard 3.5mm Music In jack on the front of the intercom. When a device is plugged in to the Music In jack, it over-rides the permanent music input.

4.6 Muting Inputs

Whenever a radio or other non-muting input has audio activity, music and muting input volume is immediately decreased to near fully-muted so that you may hear important radio transmissions or audio alerts. When audio from radios/non-muting inputs ceases for a moment (0.5 second), volume levels are automatically restored gradually over the next second.

4.7 Selectable Auto Mute (music only)

Press the squelch knob to toggle whether or not music is muted by intercom conversation as well as by non-muting input and radio activity. This allows you to set the music and aux muting input to not mute as you sing along or occasionally chat over the intercom:

- When Auto Mute is DISABLED: Only audio activity from radios and non-muting inputs will mute music.
- When Auto Mute is ENABLED: Audio from radios, non-muting inputs, and intercom conversation will mute music.

4.8 Fail-safe Operation

When power is lost or the SV-INTERCOM-2S is powered off, the primary radio is connected directly to the pilot's headset. If the pilot headset is a stereo headset, radio audio will only be heard in one ear. Intercom conversation and audio from other radios and inputs (including music) will not be heard when in this unpowered fail-safe mode.

4.9 Radio Push-to-Talk (PTT) Behavior and Priority

When the pilot or co-pilot presses a PTT switch, only the person pressing their PTT is heard over the radio.

If the pilot and co-pilot PTT buttons are both depressed, the pilot PTT takes priority. Only the pilot's voice is transmitted over the radio. Additionally, the pilot PTT will take priority from the co-pilot even if the co-pilot PTT is already depressed.

4.10 Dual Radio Operation

If two COM radios are installed, an external switch selects which radio transmits when the PTT switch is pressed. Use the radio volume control to determine which radio(s) is heard at any given moment.